

Kenny Rogers Productions, Inc. 2010
USA - Canada Production Requirements
Indoor and Outdoor and Small Venue Performances

Kenny Rogers Production staff recognizes that small venues can vary drastically ranging from theaters to hotel ballrooms to tents. Each one presents it's own set of unique challenges. Our experiences have shown us that these venues require flexibility on both parties represented. We will do everything possible to accommodate your needs without sacrificing the quality of Mr. Rogers performance.

This rider is a binding part of the attached contract.

1) Airfares: If the Purchaser is providing airfares for the Kenny Rogers group, the flights are to be "all jet service" for first class and coach tickets. All flights are to be approved by Kenny Rogers tour manager, Gene Roy, 615-777-2308, before they are booked.

2) Hawking: There is to be no selling of food, drinks or novelty items in the audience once the show has started.

3) Runner

We will need a person with a reliable car from load-in until the end of load-out. The runner is to be designated for Kenny Rogers use only.

4) Parking: Please have parking as close to the venue as possible for two (2) semi-trucks, three (3) buses and four (4) automobiles. Kenny Rogers' automobile should be allowed in the facility as close to his dressing room as possible.

5) Marquee: Kenny Rogers' name is to be the only name on the top line of your marquee. The support talent name (if any) is to be put on the line below Kenny.

6) Security: The security we need consists of the following: six (6) t-shirt security or non-uniformed police officers to be utilized at the discretion of Kenny Rogers security staff or road manager. We prefer t-shirt security and that they all be dressed uniformly for easy identification. They can wear t-shirts, shirts and ties, golf shirts or blazers. It doesn't matter to us as long as they are dressed accordingly. Please have six (6) security personnel at the venue one and one-half hour prior to show time. They are to meet with Tony Wray, Kenny's Production Assistant, upon their arrival to the building. Promptness and attire is of the utmost importance.

We normally use four (4) of these men in front of the stage , one (1) in the backstage area, and one (1) at Kenny's dressing room door.

We do not want police officers with guns around the stage.

7) Towels: A total of thirty six (36) bath towels are to be provided at load-in to the production manager. The towels are for us to use while at the venue. If an opening act is provided for this show, towels will also need to be provided for them.

8) Food: If you have any questions after reading this rider please contact the production manager, Keith Bugos at the office, 615-777-2308, or on his cell phone, 414-915-7761. The quantities listed in our rider are the quantities that we need. Please do not add extra food or drinks. Each meal quantity includes all of the Kenny Rogers crew. Please note that none of the quantities include any local stagehands, riggers, etc. that are working our show.

If we are in a building for more than one day we will need breakfast, lunch, dinner and all dressing room set ups on the first day. **On any subsequent days we will not need breakfast or lunch but we will need Dinner in addition to the dressing rooms replenished and cleaned.**

If there are two shows on the same day we will need all dressing rooms set up prior to the first show and each dressing room replenished between the two shows if needed. Hot hors d'oeuvres may be needed in Kenny's dressing room prior to the first show. The LION'S PRIDE production manager will confirm this with you if this will be needed. Kenny's hot meal will usually be served between the two shows.

In preparing for the show(s) please keep in mind:

- 1) All of our food is to be set up buffet style. There is no need for waitresses.
- 2) Heavy weight, plastic silverware and heavy weight chinet like plates are acceptable for breakfast and lunch.
- 3) Real dishes and silverware are to be used at dinner and in the dressing rooms.
- 4) Tablecloths also need to be put on tables at dinner and in all dressing rooms
- 5) The use of 16 oz. Plastic or styrofoam cups are preferred. No paper cups please.
- 6) All drinks for breakfast, lunch, dinner, and dressing rooms are to be iced down and there is to be separate fresh ice for putting in cups.
- 7) All drinks should be in cans, not glass bottles, unless there is a cold drink fountain dispenser
- 8) All condiments and utensils for our food items listed need to be furnished with each meal and in the dressing rooms, including but not limited to plates, napkins, salt, pepper, lemons, sweet 'n low, etc.
- 9) The caterer should be available at all times. If the caterer needs to leave the building for any reason, please check with the production manager, Keith Bugos, prior to leaving.
- 10) Fast food or chain restaurant food is not acceptable. It is the quality, not the excessive quantity that is requested for the Kenny Rogers touring personnel.
- 11) If the caterer provides the towels required, the towels are to be left in the building until load-out is completed. Kenny's crew needs a total of thrity six (36) towels. These are to be bath size towels. Please make sure that if the towels are new that they have been washed.
- 12) The caterer should provide two (2) bottles of softsoap, two (2) bars of Coast soap and two (2) bottles of Pert Shampoo for showers.
- 13) All drinks are to be carried over from meal to meal.
- 14) All drinks not used at the conclusion of the show should be boxed and set in production office. They will be put on the band and crew buses.
- 15) We do not have a weekly, pre-planned daily menu (example: chicken on Monday, beef on Tuesday, etc.). We would appreciate you letting us know what kind of dishes you specialize in and prepare your most popular for us.

Kenny Rogers Crew Breakfast

Crew breakfast should be set up **forty five (45) minutes prior** to the rigging/load-in call. Hot food is for the Kenny Rogers personnel only unless directed by our production manager. Kenny Rogers personnel will have backstage passes or Staff Shirts for easy identification. Please check for these before serving the hot food. **Breakfast is for Twelve (12)**. This total includes **no locals**. The quantities we need are listed below:

- 1 Six pack Diet Pepsi-Cola
- 1 Six pack Diet Sierra Mist
- 2 Six packs Pepsi-Cola
- 2 Six packs of assorted cold drinks
- 8 Quarts of milk (4 quarts whole milk, 4 quarts non-fat milk)
- 4 Quarts of assorted fruitjuices (apple, grape, orange, etc>)
- 48 8 oz bottles of spring water (plastic with screw on top)
- 1 Small can of chocolate Nestles Quick
- 12 Individual servings of assorted cereal (Including Rasin Brand)
- 1 Bunch of ripe bananas
- 5 Servings of assorted fresh fruit, such as apples, seedless grapes, pears, etc.
- 1 Loaf of white bread
- 1 Loaf of whole wheat bread
- 1 Lb. of margarine
- 1 Small jar of honey
- 1 Small jar of jam or jelly
- 1 Small jar of crunchy peanut butter
- 2 Dozen assorted donuts
- 1 Bag of ground **Starbucks** coffee (house blend)
- 3 Dozen eggs (**to be cooked to order by cook on call**)
- 3 Lbs. Bacon
- 1 Gallon of fresh brewed tea—unsweetened, instant is not acceptable
- 1 Toaster – Please make sure this is working before breakfast begins
- 1 Quart Fat Free Coffeemate French Vanilla
- 1 Quart regular liquid French Vanilla
- 20 Lbs. of ice for one (1) crew bus

Coffee, hot tea, and iced tea should be set up at breakfast and be replenished as needed throughout the day. The coffee set up, however, should be left in the building from breakfast all the way through load-out.

Please set up a coffee and tea service by the load-in door for the building personnel. The building personnel are not allowed in the breakfast room until lunch time.

Please check with our production manager, Keith Bugos, before breaking down breakfast.

Kenny Rogers Crew Lunch

The crew lunch should be set up in two different shifts, normally at 12:00 and 12:30 PM. The production manager will let you know, once he has confirmed the load-in time and the menu. However, the production manager has the authority to change the times for serving lunch the day of the show.

We require **fifteen (15) hot meals** such as barbeque, hamburgers, french dip, stir fry, tacos, etc and **SIX (6)** grilled, skinless, boneless, spicy (canjun, jerk) chicken breasts. Any suggestions you may have are greatly appreciated as we are open to trying something different.

If the purchaser elects to provide meals for the local crew, please increase the quantities to the above total.

The items listed below will also be needed **along with** the hot entree:

- 1 Large loaf of wheat bread
- 2 Lb's. of shaved **non-processed** turkey (mesquite, honey baked, smoked, etc.)
- 24 Pack assorted cheese slices including American
- 1 Quart small cottage cheese
- 1 Quart of tuna salad
- 1 Quart of either chicken salad, egg salad
- 2 Gallons of soup (if the weather is warm this item may be deleted and replaced with potato salad, cole slaw, etc.)
- 1 Large veggie tray
- 1 Case of assorted cold drinks – Coca-Cola, Diet Coca-Cola, etc.
- 1/2 Case Pepsi-Cola
- 1/2 Case Diet Pepsi-Cola
- 1 Case of Mountain Dew

Please have a full arrangement of condiments including Miracle Whip Salad Dressing, mayonnaise, French's mustard and Grey Poupon mustard etc.

Please see the production manager regarding the time to break down lunch.

Kenny Rogers Crew Dinner

The Kenny Rogers crew dinner should be set up two and one half (2 1/2) hours prior to show time. There will be a total of **twenty two (22) people for dinner**. This total includes Kenny Rogers staff . The dinner is to be a hot meal. **If the purchaser elects to provide meals for the local crew please add those meals to the above total.**

The twenty (20) people are to be served meat along with two fresh vegetables (one green), a starch (such as potatoes, macaroni & cheese, etc.) Bread (such as cornbread, rolls, biscuits, etc.), a tossed salad with an assortment of dressings including a caesar salad dressing plus a dessert.

Eight (8) people, out of the above totals are to be served (no-red-meat) meals.

Fowl or fresh seafood are preferred along with two fresh vegetables, a starch, bread, salad and dessert.

(Beef, Pork, Mutton and Goat are red meat along with any animal with a hoof.)

In addition to the hot meals we will also need the items listed below:

- 1/2 Case of assorted cold drinks
- 1 Six pack Diet Sierra Mist
- 1 Case of Diet Coca-Cola
- 1/2 Case of Coca-Cola
- 12 Cans of Red Bull
- 1 Quart of skim milk
- 1 Quart of 2% milk
- 24 8 oz bottles of spring water (plastic with screw top)

All food at dinner is to be served on hot plates or warmers and set up buffet style.

Any remaining drinks after the show are handled per Keith Bugos 's instructions.

Remember: real dishes, silverware and tablecloths are to be used at dinner.

Please provide separate dishes for salad and dessert.

If Kenny is eating his hot meal in-between show times, please provide him with a meat and cheese deli tray, pizza or hot hor d'oeuvres such as hot chicken fingers prior to the first show.

Kenny Rogers and Band Dressing Rooms:

Kenny Rogers' dressing room, along with the band dressing room, must be set up three (3) hours prior to show time. Timing is of the utmost importance. Please check with Keith Bugos, production manager, prior to setting up any of Kenny's dressing room food. You can reach Keith at 414-915-7761 cell.

Please provide condiments & openers.

Kenny Rogers Dressing Room

The following items are required for the dressing room of Kenny Rogers:

- 1 Hot tea service (please be certain the hot water is on a burner to stay warm and not served in a thermos. Also, please do not run the water through a coffee maker to get hot as this leaves a coffee taste)
- 5 Servings of fresh fruit such as apples, bananas, seedless grapes
- 1 Six pack of Diet Coca-Cola with caffeine
- 1 Six pack of Diet Coca-Cola caffeine free
- 1 Lb. each of M&M's plain and peanut candies
- 1 Bag assorted Hershey's miniature chocolate candy bars
- 6 Bottles of Evian water
- 2 (4) pack of Starbucks - Double Shot Espresso cans
- 1 Bucket of clean ice for drinks

Band Dressing Room:

The following items are required for the dressing room of the Band:

- 1 Quart cranberry juice
- 1 Six pack of assorted cold drinks (including ginger ale)
- 1 Box assorted chocolate candies
- 1 Lb. each of M&M's plain and peanut candies
- 1 Bag assorted Hershey's miniature chocolate candy bars
- 1 Six pack can of Diet Coca-Cola
- 1 Six pack cans of regular Coca-Cola
- 1 Six pack cans of Diet Pepsi
- 1 Six pack cans of Mountain Dew
- ½ Case of can imported Samuel Adams beer
- 1 Quart Vitamin D whole milk
- 1 Quart 2% milk
- 2 Cases of Evian Water - 1 case iced down & 1 case at room temperature
- 1 Liter Glen Livet Scotch
- 1 Quart Gentleman Jack Whiskey
- 3 six-packs total mixture of Heineken Beer, New Castle Beer, Imported beer, whatever brand is available in your area)
- 1 Bottle of Beringer or Vendage White Zinfandel Wine
- 1 Bottle of Kendall Jackson Cabernet or any red wine
- 1 Six pack of assorted Propel Sports Drink

Please initial and fax back _____

- 4 Pack of Starbucks Coffee Frappuccino (coffee flavored-not caramel)
- 1 Bag of Starbucks House Blend or Columbian ground coffee
- 2 Servings of capped strawberries, cut into bite size pieces (no sugar added)
- 1 Quart Half & Half
- 1 Pint liquid whipping cream (not in a can)
- 6 Atkins Advantage no carb bars assorted flavors including peanut butter, cookies and cream, s'mores, coconut (available at GNC)
- 12 Person coffee service (please be certain the hot water is on a burner and not served in a thermos bottle and not run through a coffee maker)

The following items are to be left in bags to go on the buses:

- 1 Roll of paper towels
- 1 Large bag of regular Sun Chips
- 1 Large bag of Tostitos
- 1 Large bag of Lays Original Potato Chips
- 1 Box Lays variety lunch size bags of chips
- 1 Variety pack of assorted cereals
- 1 Box Act II butter microwave popcorn
- 2 Bags Chips Ahoy cookies
- 1 Glass jar Planters fully salted dry roasted peanuts
- 1 Can Planters deluxe mixed nuts
- 1 Can Planters cashews
- 1 Bag chocolate Hershey's miniature candy bars
- 1 Bag plain Beef Jerkey
- 1 Bag plain Turkey Jerkey
- 1 Box assorted granola bars
- 12 Cans Red Bull

The following meats must be kept cold to go on buses:

- 1 Package Oscar Mayer bologna
- 1 Package Oscar Mayer hard salami
- 1/2 Lb. of deli Mesquite smoked turkey – no pressed meat

Once Kenny's dressing room is set up with all that is requested, please check with Keith Bugos. If you do need to go back into Kenny's dressing room once everything is set up, please consider Kenny and the band and **knock** before entering the dressing room. Remember: real silverware, china and tablecloths are to be used in Kenny's dressing room. Timing in setting up Kenny's dressing room is very important!

9) Dressing rooms: The following dressing rooms are necessary for the presentation of our show:

- a) Kenny Rogers and band dressing room should be one large room in a secured area as close to the stage as possible.
It should include four (4) 8' tables plus twelve (12) chairs.

b) Support talent dressing room with chairs and table for placement of food if there is an opening act.

c) Production Room: **Must have one telephone line and one “completely open” Hi Speed Internet line dedicated to KRP** . The phone line shall be restricted to local calls only. They must be analog and not thru a switch board operator. If we need to call long distance, we will use our phone card. If there are no phones in your touring production office at present, please call Keith Bugos @ 414-915-7761 (central time).

d) Road crew production room needs to have shower facilities whenever possible or at least be near access to showers. The road crew room should have about ten (10) chairs for comfort of the crew.

All rooms are to be well lit, have tables , chairs, trash cans, electrical outlets, and all dressing rooms need to have mirrors, separate toilet facilities with soap and garment racks.

10) Wardrobe person: We will need a wardrobe person starting four (4) hours prior to show time to press Kenny's and the band's clothing. The wardrobe person will need to bring an iron, ironing board, small sewing kit, and a commercial upright steamer. The wardrobe person will need to check with Tony Wray, Kenny's Production Assistant, upon their arrival. Tony can usually be found in the production office.

The promptness of the wardrobe person is very important . They also need to be a professional as the clothing they will be handling is quite fragile.

The wardrobe person may be required to stay through the show.

11) Stage Outdoor: The stage for the Kenny Rogers show is to be 60' wide x 48' deep x 4' high with 16' x 12' sound risers on each side, stage height. The stage should be properly draped, have a suitable backdrop (black is preferred) and a load bearing, covered roof in case of bad weather (if this is an outdoor show). Two (2) fifty foot rolls of clear plastic covering (6 mill rain protection for KRP band gear and consoles) must be on site **before the load-in can start**. The monitor position (stage left) must be covered with a tent with **side panels** not to be less in size than 12 feet x 14 feet (NOT an EZ-up).

12) Stage Indoor & Small: The stage for the Kenny Rogers show is to be a minimum of 60' wide x 40' deep with a height of three feet or but not more than four feet. If sound is to be stacked, wings will also be required. The stage should be properly draped and have a suitable backdrop.

- a) No dance floors are allowed within the confines of the performance area at any time.
- b) There must be seating immediately in front of the stage to the back of the house, with no more than the required distance for a fire aisle between the stage and the first row.

13) Move in: If Kenny Rogers supplements any sound and/or lights at the venue, listed below is the order which our equipment is moved in and assembled:

- a) Truck(s) unloaded
- b) Truck(s) parked to facilitate a quick load-out.
- c) Lighting is assembled and hung
- d) Sound is hung
- e) Band gear is put in place

14) Power: The below listed power is needed for Kenny's lights and sound and these services are for our use **only**. Let us know if you can not provide the power needed:

600 amps per leg-three phase- 120/208 volts- 5 wire 75' of stage for **lights**.

100 amps per leg-three phase- 120/208 volts- 5 wire 75' of the stage for **sound**.
((To be located at the (DownStage Left) lip of stage))

15) Spotlights: The stage set up will require a total of four (4) house spotlights (1.6K Zenon Minimum). The location of the spotlights will be determined by Kenny Rogers' stage manager. Spotlights must be at minimum ten feet off the floor and as high as the venue will allow. **400 Watt follow-spot are UNACCEPTABLE**

16) Spotlight gels: We will require gels for the spotlights in the following roscoe colors:

order number:	<u>1</u>	<u>2</u>	<u>3</u>	<u>4</u>	<u>5</u>	<u>6</u>
Roscoe number:	33	34-99	49	80	58	22

17) Intercom: You must provide a complete two way intercom system to all four (4) spotlights, house lights and mix locations. This intercom is to be provided by the facility in which Kenny Rogers is performing. The facility system will be used exclusively unless unsatisfactory to the Stage Manager. Please let us know if you do not have an intercom system.

18) Sound & Light mix locations: placement of the mix locations is very important.

Indoor facility: The mix location for the sound should be approximately seventy-five feet (75') from the stage. The mix location sits flat on the floor and does not require a riser. It sits in a 10' wide x 8' deep area. Kill fourteen (14) seats (two rows of seven) for the sound mix.

The lighting mix should go in an exit or with the sound mix area on the main floor. We will need a 12' wide x 8' deep x 2' high riser for the lighting mix.

Outdoor facility: The sound and light mix should both be approximately seventy-five feet (75') from the stage. The sound board will take up an area of 10' wide x 8' deep and sit flat of the floor. The lighting mix will take up a 12' wide x 8' deep area and should be placed directly behind the sound mix on a two foot (2') high riser.

19) Sound Requirements:

A. HOUSE SOUND SYSTEM:

1. HOUSE SPEAKERS: (listed in order of preference)

Totals given below in STACKING are based on sound wings, proscenium stage, and stacking the speakers in a some what narrow splay (50 degrees) for 4000 capacity venue.

If there is a upper deck or the room is extra long / wide additional delay speaker may be needed. The amount of speaker will very depending on the size of the venue and/or the spread of the patrons. Our goal is even coverage not excessive volume.

Manufacturers	Model	Totals
Clair Bros.	Line array	16
JBL	Line array	16
EAW	Line array	16
QSC	Line array	16
Meyers Sound	Line array	16
EV	Line array	16
V-Dosc	Line array	16

The use of anything not listed must be cleared by KRP.

- 2. HOUSE DRIVE RACK: as needed.
- 3. Front Fill / Side Fill -Speakers as needed

20) Stage call:

Rigging & load-in call:

Lights and sound to be **up and ready upon KRP crew load-in 10:00 A.M.**

4 riggers (3 up, 1 down)

4 loaders

12 stagehands

1 hook up electrician

1 forklift with operator (forklift to be fueled and ready for use. 5,000 lb capacity, 15' lift)

All of the above will be needed most of the day. **No Doubling!**

Show call: 30 minutes prior to show time

1 house light operator

4 spotlight operators

The number of deck men depends on show requirements and you will be notified in advance for the number needed.

1 electrician

Load-out: 2-2 1/2 hours after scheduled show time

4 riggers (3 up, 1 down)

4 loaders

14 stagehands

1 hook up electrician

1 forklift with operator (forklift to be fueled and ready for use. 5,000 lb capacity, 15' lift)

Load-out of our equipment will take approximately 2 1/2 hours after the conclusion of our show.

A total of **sixty pounds (60 lbs) of ice** will be needed at the conclusion of the show. This ice will be placed on Kenny' s buses. Please check with Keith Bugos the morning of the show to make sure the ice will be needed before you go through the trouble of getting it.

21) Load-out food:

HOT food from a local restaurant (pizza, Steak & Shake, Chinese or Indian food) should be put on the crew bus after load-out for twelve (12) road crew. Please see Frank Farrell about this.

All remaining food items and drinks will be relocated after the conclusion of the show per the instructions of Keith Bugos. Again, please check with the production manager the morning of the show to make sure that the items listed above will actually be needed.

Please make sure that a coffee/drink service is located near the load-in doors and is available throughout load-out.

Upstage 34'
30" double hung PRT

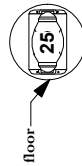
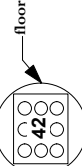
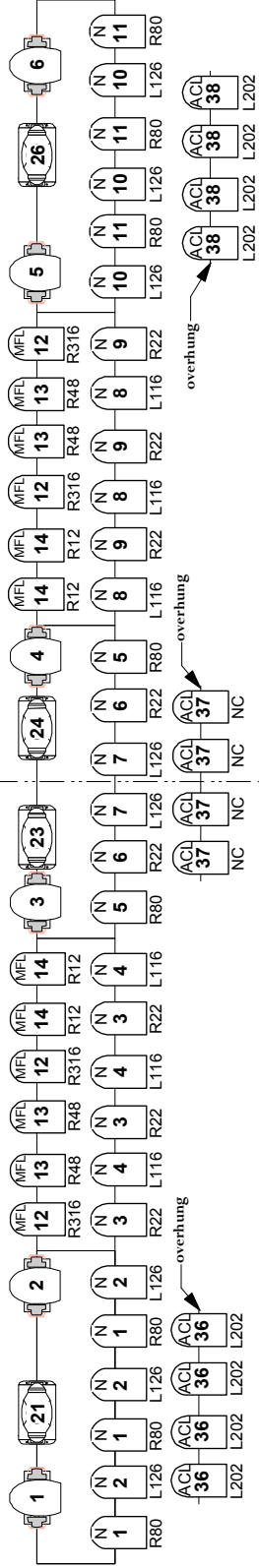

Midstage 24'
20" Truss

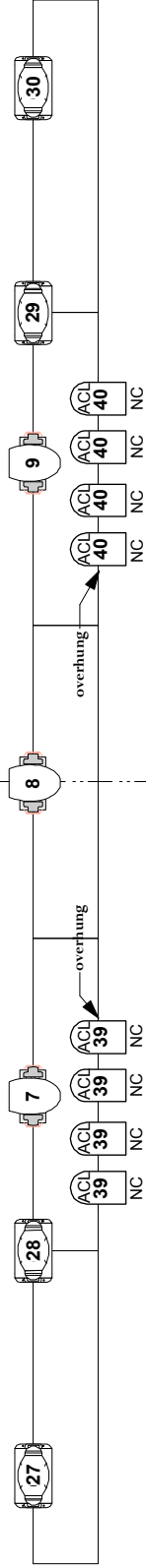

All S4 19° overhung

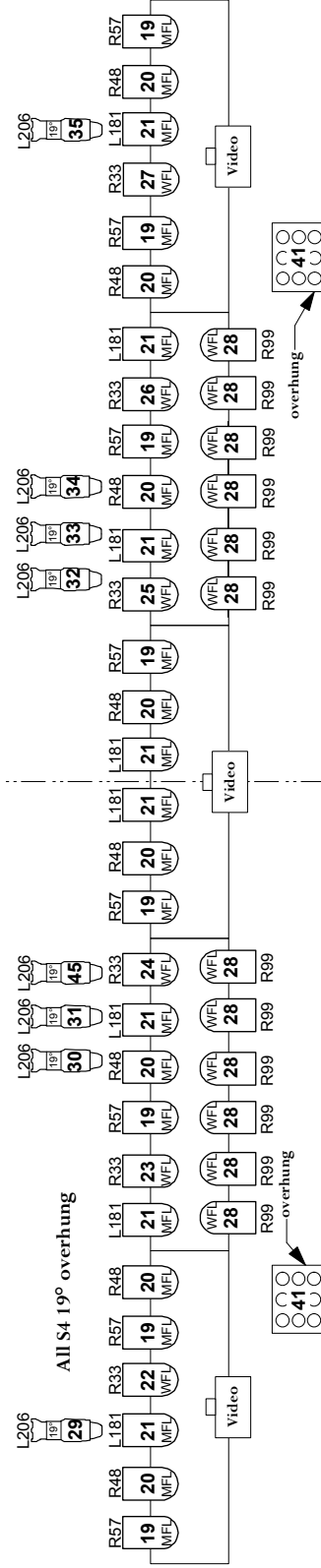

Downstage 0'
30" double hung PRT

Followspot Colour

Frame 1:	R33
Frame 2:	R99 (spots 1 & 4)
Frame 2:	R34 (spots 2 & 3)
Frame 3:	R49
Frame 4:	R80
Frame 5:	R58
Frame 6:	R22

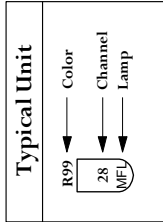

Key

	VL Spot		Studio Beam
	Par 64, 1k		9 Light, DWE 650w
	19° Source 4, 750w		3 cell Far Cyc, 1k
	S4 Par WFL, 575w		

KENNY ROGERS
Lighting Designer: Jeff Metter
2010
Drawn by: LJS

Kenny Rogers Lighting Hookup 2010

Channel	Dimmer	Position	Instrument Type	Wattage	Color
(1)		US TRUSS	Par 64 NSP	1kw	R80
(1)		US TRUSS	Par 64 NSP	1kw	R80
(1)		US TRUSS	Par 64 NSP	1kw	R80
(2)		US TRUSS	Par 64 NSP	1kw	L126
(2)		US TRUSS	Par 64 NSP	1kw	L126
(2)		US TRUSS	Par 64 NSP	1kw	L126
(3)		US TRUSS	Par 64 NSP	1kw	R22
(3)		US TRUSS	Par 64 NSP	1kw	R22
(3)		US TRUSS	Par 64 NSP	1kw	R22
(4)		US TRUSS	Par 64 NSP	1kw	L116
(4)		US TRUSS	Par 64 NSP	1kw	L116
(4)		US TRUSS	Par 64 NSP	1kw	L116
(5)		US TRUSS	Par 64 NSP	1kw	R80
(5)		US TRUSS	Par 64 NSP	1kw	R80
(6)		US TRUSS	Par 64 NSP	1kw	R22
(6)		US TRUSS	Par 64 NSP	1kw	R22
(7)		US TRUSS	Par 64 NSP	1kw	L126
(7)		US TRUSS	Par 64 NSP	1kw	L126
(8)		US TRUSS	Par 64 NSP	1kw	L116
(8)		US TRUSS	Par 64 NSP	1kw	L116
(8)		US TRUSS	Par 64 NSP	1kw	L116
(9)		US TRUSS	Par 64 NSP	1kw	R22
(9)		US TRUSS	Par 64 NSP	1kw	R22
(9)		US TRUSS	Par 64 NSP	1kw	R22
(10)		US TRUSS	Par 64 NSP	1kw	L126
(10)		US TRUSS	Par 64 NSP	1kw	L126
(10)		US TRUSS	Par 64 NSP	1kw	L126
(11)		US TRUSS	Par 64 NSP	1kw	R80
(11)		US TRUSS	Par 64 NSP	1kw	R80
(11)		US TRUSS	Par 64 NSP	1kw	R80
(12)		US TRUSS	Par 64 MFL	1kw	R316
(12)		US TRUSS	Par 64 MFL	1kw	R316
(12)		US TRUSS	Par 64 MFL	1kw	R316
(12)		US TRUSS	Par 64 MFL	1kw	R316
(13)		US TRUSS	Par 64 MFL	1kw	R48
(13)		US TRUSS	Par 64 MFL	1kw	R48
(13)		US TRUSS	Par 64 MFL	1kw	R48
(13)		US TRUSS	Par 64 MFL	1kw	R48
(14)		US TRUSS	Par 64 MFL	1kw	R12
(14)		US TRUSS	Par 64 MFL	1kw	R12
(14)		US TRUSS	Par 64 MFL	1kw	R12
(14)		US TRUSS	Par 64 MFL	1kw	R12
(19)		DS TRUSS	Par 64 MFL	1kw	R57
(19)		DS TRUSS	Par 64 MFL	1kw	R57
(19)		DS TRUSS	Par 64 MFL	1kw	R57
(19)		DS TRUSS	Par 64 MFL	1kw	R57
(19)		DS TRUSS	Par 64 MFL	1kw	R57
(19)		DS TRUSS	Par 64 MFL	1kw	R57
(19)		DS TRUSS	Par 64 MFL	1kw	R57
(19)		DS TRUSS	Par 64 MFL	1kw	R57
(19)		DS TRUSS	Par 64 MFL	1kw	R57
(20)		DS TRUSS	Par 64 MFL	1kw	R48
(20)		DS TRUSS	Par 64 MFL	1kw	R48

Kenny Rogers Lighting Hookup 2010

(20)		DS TRUSS	Par 64 MFL	1kw	R48
(20)		DS TRUSS	Par 64 MFL	1kw	R48
(20)		DS TRUSS	Par 64 MFL	1kw	R48
(20)		DS TRUSS	Par 64 MFL	1kw	R48
(20)		DS TRUSS	Par 64 MFL	1kw	R48
(20)		DS TRUSS	Par 64 MFL	1kw	R48
(21)		DS TRUSS	Par 64 MFL	1kw	L181
(21)		DS TRUSS	Par 64 MFL	1kw	L181
(21)		DS TRUSS	Par 64 MFL	1kw	L181
(21)		DS TRUSS	Par 64 MFL	1kw	L181
(21)		DS TRUSS	Par 64 MFL	1kw	L181
(21)		DS TRUSS	Par 64 MFL	1kw	L181
(21)		DS TRUSS	Par 64 MFL	1kw	L181
(21)		DS TRUSS	Par 64 MFL	1kw	L181
(21)		DS TRUSS	Par 64 MFL	1kw	L181
(22)		DS TRUSS	Par 64 WFL	1kw	R33
(23)		DS TRUSS	Par 64 WFL	1kw	R33
(24)		DS TRUSS	Par 64 WFL	1kw	R33
(25)		DS TRUSS	Par 64 WFL	1kw	R33
(26)		DS TRUSS	Par 64 WFL	1kw	R33
(27)		DS TRUSS	Par 64 WFL	1kw	R33
(28)		DS TRUSS	Par 64 WFL	1kw	R99
(28)		DS TRUSS	Par 64 WFL	1kw	R99
(28)		DS TRUSS	Par 64 WFL	1kw	R99
(28)		DS TRUSS	Par 64 WFL	1kw	R99
(28)		DS TRUSS	Par 64 WFL	1kw	R99
(28)		DS TRUSS	Par 64 WFL	1kw	R99
(28)		DS TRUSS	Par 64 WFL	1kw	R99
(28)		DS TRUSS	Par 64 WFL	1kw	R99
(29)		DS TRUSS	19° S4	750w	L206
(30)		DS TRUSS	19° S4	750w	L206
(31)		DS TRUSS	19° S4	750w	L206
(32)		DS TRUSS	19° S4	750w	L206
(33)		DS TRUSS	19° S4	750w	L206
(34)		DS TRUSS	19° S4	750w	L206
(35)		DS TRUSS	19° S4	750w	L206
(36)		US TRUSS	ACL	250w	L202
(36)		US TRUSS	ACL	250w	L202
(36)		US TRUSS	ACL	250w	L202
(36)		US TRUSS	ACL	250w	L202
(37)		US TRUSS	ACL	250w	NC
(37)		US TRUSS	ACL	250w	NC
(37)		US TRUSS	ACL	250w	NC
(37)		US TRUSS	ACL	250w	NC
(38)		US TRUSS	ACL	250w	L202
(38)		US TRUSS	ACL	250w	L202
(38)		US TRUSS	ACL	250w	L202
(38)		US TRUSS	ACL	250w	L202
(39)		MS TRUSS	ACL	250w	NC
(39)		MS TRUSS	ACL	250w	NC
(39)		MS TRUSS	ACL	250w	NC
(39)		MS TRUSS	ACL	250w	NC
(40)		MS TRUSS	ACL	250w	NC
(40)		MS TRUSS	ACL	250w	NC

Kenny Rogers Lighting Hookup 2010

(40)		MS TRUSS	ACL	250w	NC
(40)		MS TRUSS	ACL	250w	NC
(41)		DS TRUSS	9 Lite	650w DWE	NC
(41)		DS TRUSS	9 Lite	650w DWE	NC
(42)		FLOOR	9 Lite	650w DWE	NC
(45)		DS TRUSS	19° S4	750w	L206

Kenny Rogers Color Count

Channel	Dimmer	Position	Instrument Type	Wattage	Color	Total Cuts
(14)		US TRUSS	Par 64 MFL	1kw	R12	
(14)		US TRUSS	Par 64 MFL	1kw	R12	
(14)		US TRUSS	Par 64 MFL	1kw	R12	
(14)		US TRUSS	Par 64 MFL	1kw	R12	4
(12)		US TRUSS	Par 64 MFL	1kw	R316	
(12)		US TRUSS	Par 64 MFL	1kw	R316	
(12)		US TRUSS	Par 64 MFL	1kw	R316	
(12)		US TRUSS	Par 64 MFL	1kw	R316	4
(3)		US TRUSS	Par 64 NSP	1kw	R22	
(3)		US TRUSS	Par 64 NSP	1kw	R22	
(3)		US TRUSS	Par 64 NSP	1kw	R22	
(6)		US TRUSS	Par 64 NSP	1kw	R22	
(6)		US TRUSS	Par 64 NSP	1kw	R22	
(9)		US TRUSS	Par 64 NSP	1kw	R22	
(9)		US TRUSS	Par 64 NSP	1kw	R22	
(9)		US TRUSS	Par 64 NSP	1kw	R22	
			Followspot 1		R22	
			Followspot 2		R22	
			Followspot 3		R22	
			Followspot 4		R22	12 (not all the same size)
(22)		DS TRUSS	Par 64 WFL	1kw	R33	
(23)		DS TRUSS	Par 64 WFL	1kw	R33	
(24)		DS TRUSS	Par 64 WFL	1kw	R33	
(25)		DS TRUSS	Par 64 WFL	1kw	R33	
(26)		DS TRUSS	Par 64 WFL	1kw	R33	
(27)		DS TRUSS	Par 64 WFL	1kw	R33	
			Followspot 1		R33	
			Followspot 2		R33	
			Followspot 3		R33	
			Followspot 4		R33	10 (not all the same size)
			Followspot 1		R34	
			Followspot 2		R34	
			Followspot 3		R34	
			Followspot 4		R34	4
(13)		US TRUSS	Par 64 MFL	1kw	R48	
(13)		US TRUSS	Par 64 MFL	1kw	R48	
(13)		US TRUSS	Par 64 MFL	1kw	R48	
(13)		US TRUSS	Par 64 MFL	1kw	R48	
(20)		DS TRUSS	Par 64 MFL	1kw	R48	
(20)		DS TRUSS	Par 64 MFL	1kw	R48	
(20)		DS TRUSS	Par 64 MFL	1kw	R48	
(20)		DS TRUSS	Par 64 MFL	1kw	R48	
(20)		DS TRUSS	Par 64 MFL	1kw	R48	

Kenny Rogers Color Count

(20)		DS TRUSS	Par 64 MFL	1kw	R48	
(20)		DS TRUSS	Par 64 MFL	1kw	R48	
(20)		DS TRUSS	Par 64 MFL	1kw	R48	12
			Followspot 1		R49	
			Followspot 2		R49	
			Followspot 3		R49	
			Followspot 4		R49	4
(19)		DS TRUSS	Par 64 MFL	1kw	R57	
(19)		DS TRUSS	Par 64 MFL	1kw	R57	
(19)		DS TRUSS	Par 64 MFL	1kw	R57	
(19)		DS TRUSS	Par 64 MFL	1kw	R57	
(19)		DS TRUSS	Par 64 MFL	1kw	R57	
(19)		DS TRUSS	Par 64 MFL	1kw	R57	
(19)		DS TRUSS	Par 64 MFL	1kw	R57	
(19)		DS TRUSS	Par 64 MFL	1kw	R57	8
			Followspot 1		R58	
			Followspot 2		R58	
			Followspot 3		R58	
			Followspot 4		R58	4
(1)		US TRUSS	Par 64 NSP	1kw	R80	
(1)		US TRUSS	Par 64 NSP	1kw	R80	
(1)		US TRUSS	Par 64 NSP	1kw	R80	
(5)		US TRUSS	Par 64 NSP	1kw	R80	
(5)		US TRUSS	Par 64 NSP	1kw	R80	
(11)		US TRUSS	Par 64 NSP	1kw	R80	
(11)		US TRUSS	Par 64 NSP	1kw	R80	
(11)		US TRUSS	Par 64 NSP	1kw	R80	
			Followspot 1		R80	
			Followspot 2		R80	
			Followspot 3		R80	
			Followspot 4		R80	12 (not all the same size)
(28)		DS TRUSS	Par 64 WFL	1kw	R99	
(28)		DS TRUSS	Par 64 WFL	1kw	R99	
(28)		DS TRUSS	Par 64 WFL	1kw	R99	
(28)		DS TRUSS	Par 64 WFL	1kw	R99	
(28)		DS TRUSS	Par 64 WFL	1kw	R99	
(28)		DS TRUSS	Par 64 WFL	1kw	R99	
(28)		DS TRUSS	Par 64 WFL	1kw	R99	
(28)		DS TRUSS	Par 64 WFL	1kw	R99	
			Followspot 1		R99	
			Followspot 2		R99	
			Followspot 3		R99	
			Followspot 4		R99	12 (not all the same size)

Kenny Rogers Color Count

(4)		US TRUSS	Par 64 NSP	1kw	L116	
(4)		US TRUSS	Par 64 NSP	1kw	L116	
(4)		US TRUSS	Par 64 NSP	1kw	L116	
(8)		US TRUSS	Par 64 NSP	1kw	L116	
(8)		US TRUSS	Par 64 NSP	1kw	L116	
(8)		US TRUSS	Par 64 NSP	1kw	L116	6
(2)		US TRUSS	Par 64 NSP	1kw	L126	
(2)		US TRUSS	Par 64 NSP	1kw	L126	
(2)		US TRUSS	Par 64 NSP	1kw	L126	
(7)		US TRUSS	Par 64 NSP	1kw	L126	
(7)		US TRUSS	Par 64 NSP	1kw	L126	
(10)		US TRUSS	Par 64 NSP	1kw	L126	
(10)		US TRUSS	Par 64 NSP	1kw	L126	
(10)		US TRUSS	Par 64 NSP	1kw	L126	8
(21)		DS TRUSS	Par 64 MFL	1kw	L181	
(21)		DS TRUSS	Par 64 MFL	1kw	L181	
(21)		DS TRUSS	Par 64 MFL	1kw	L181	
(21)		DS TRUSS	Par 64 MFL	1kw	L181	
(21)		DS TRUSS	Par 64 MFL	1kw	L181	
(21)		DS TRUSS	Par 64 MFL	1kw	L181	
(21)		DS TRUSS	Par 64 MFL	1kw	L181	
(21)		DS TRUSS	Par 64 MFL	1kw	L181	8
(36)		US TRUSS	ACL	250w	L202	
(36)		US TRUSS	ACL	250w	L202	
(36)		US TRUSS	ACL	250w	L202	
(36)		US TRUSS	ACL	250w	L202	
(38)		US TRUSS	ACL	250w	L202	
(38)		US TRUSS	ACL	250w	L202	
(38)		US TRUSS	ACL	250w	L202	
(38)		US TRUSS	ACL	250w	L202	8
(29)		DS TRUSS	19° S4	750w	L206	
(30)		DS TRUSS	19° S4	750w	L206	
(31)		DS TRUSS	19° S4	750w	L206	
(32)		DS TRUSS	19° S4	750w	L206	
(33)		DS TRUSS	19° S4	750w	L206	
(34)		DS TRUSS	19° S4	750w	L206	
(35)		DS TRUSS	19° S4	750w	L206	
(45)		DS TRUSS	19° S4	750w	L206	8
(37)		US TRUSS	ACL	250w	NC	
(37)		US TRUSS	ACL	250w	NC	
(37)		US TRUSS	ACL	250w	NC	
(37)		US TRUSS	ACL	250w	NC	

Kenny Rogers Color Count

(39)		MS TRUSS	ACL	250w	NC	
(39)		MS TRUSS	ACL	250w	NC	
(39)		MS TRUSS	ACL	250w	NC	
(39)		MS TRUSS	ACL	250w	NC	
(40)		MS TRUSS	ACL	250w	NC	
(40)		MS TRUSS	ACL	250w	NC	
(40)		MS TRUSS	ACL	250w	NC	
(40)		MS TRUSS	ACL	250w	NC	
(41)		DS TRUSS	9 Lite	650w DWE	NC	
(41)		DS TRUSS	9 Lite	650w DWE	NC	
(42)		FLOOR	9 Lite	650w DWE	NC	

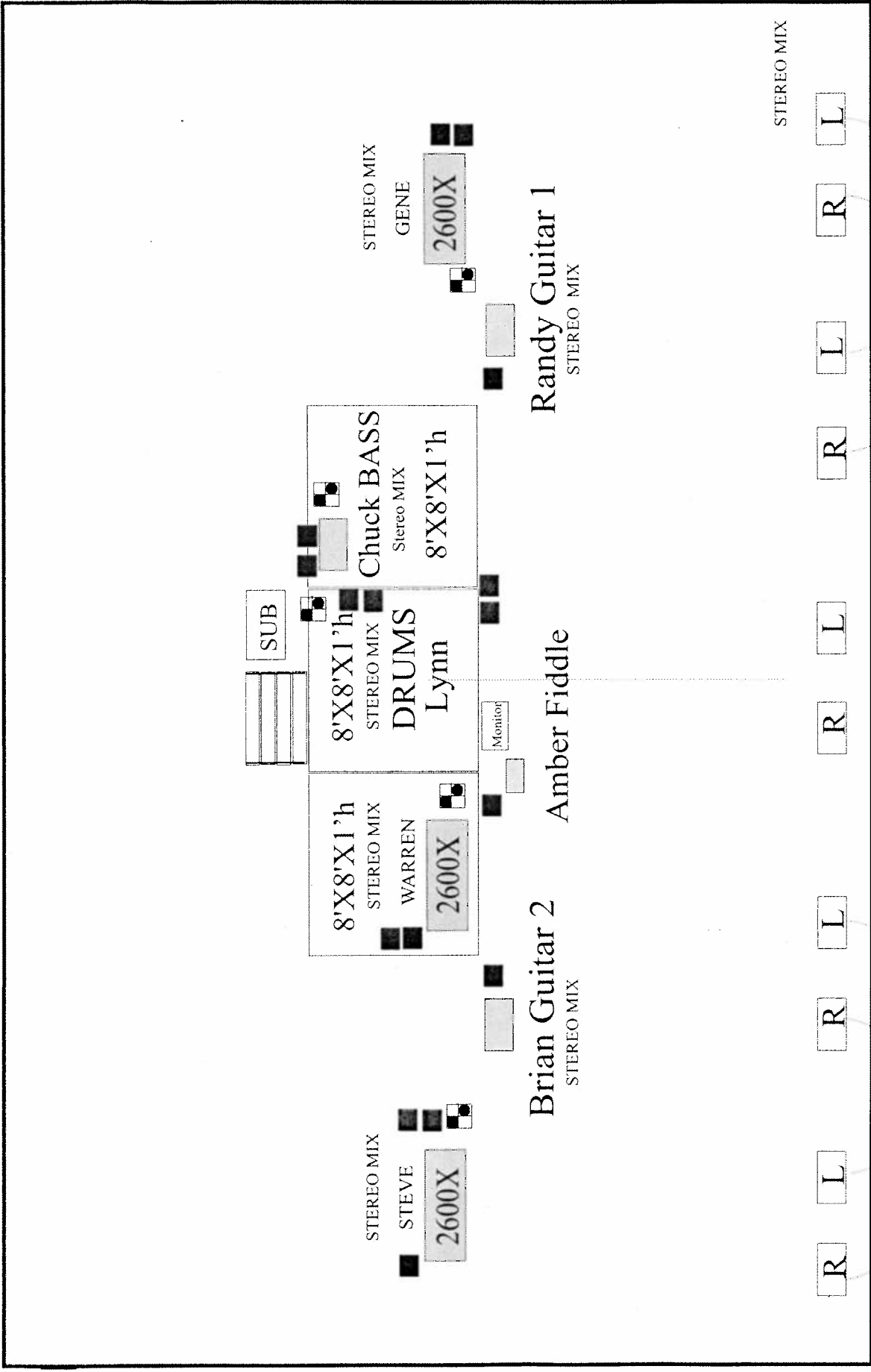

■ = Quad 15 Amp- 120VAC
 ■ = DI

Kenny Rogers Proscenium 2009
 60' X 40'